



ST 010 106 5705



- with CASCADE structure
- 200mm projection
- fixed spout
- rectangular spray pattern with 40 individual jets
- height of mixer 343 mm
- height up to aerator 329 mm
- hole diameter valve 32 mm
- hole diameter spout 35 mm
- rosette 60 x 47 mm
- 2x screw-in M 10 x 1 pressure hose, leak-tested
- max. flow 4 l/min
- lead-free
- This product can help a building meet the requirements of Green Building Rating Systems, e.g. LEED®, BREEAM®, DGNB

|  |                       |                    |
|--|-----------------------|--------------------|
|  | Brushed Platinum      | ST 010 106 5705-06 |
|  | Chrome                | ST 010 106 5705-00 |
|  | Brushed Dark Platinum | ST 010 106 5705-99 |

**Individual components of this set**

You need the following components for this set



1x 13 717 705-06



1x 20 006 705-06



1x 20 006 706-06



## CL.1 Three-hole basin mixer without pop-up waste - Brushed Platinum

---







CL.1

ST 010 106 5705

ST 010 106 5705



- 200mm projection
- fixed spout
- rectangular spray pattern with 40 individual jets
- height of mixer 343 mm
- height up to aerator 329 mm
- hole diameter 35 mm
- max. flow 4 l/min
- 1/2" connection
- 2x screw-in M 10 x 1 pressure hose, leak-tested
- lead-free
- This product can help a building meet the requirements of Green Building Rating Systems, e.g. LEED®, BREEAM®, DGNB

|  |                               |               |
|--|-------------------------------|---------------|
|  | Brushed Platinum              | 13 717 705-06 |
|  | Chrome                        | 13 717 705-00 |
|  | Dark Chrome                   | 13 717 705-19 |
|  | Brushed Champagne (22kt Gold) | 13 717 705-46 |
|  | Champagne (22kt Gold)         | 13 717 705-47 |
|  | Brushed Dark Platinum         | 13 717 705-99 |

ST 010 106 5705

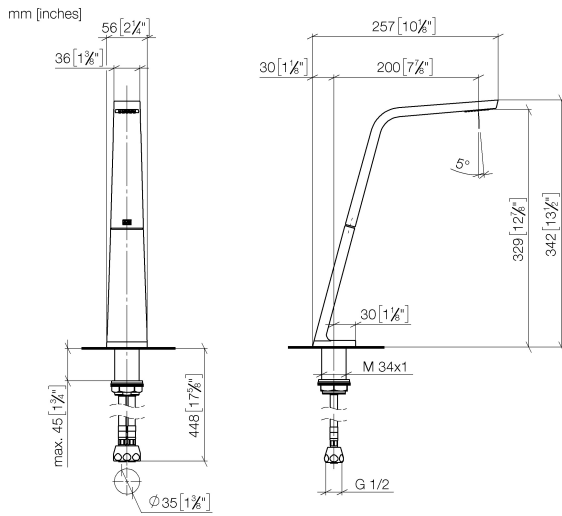

**Flow rate chart**

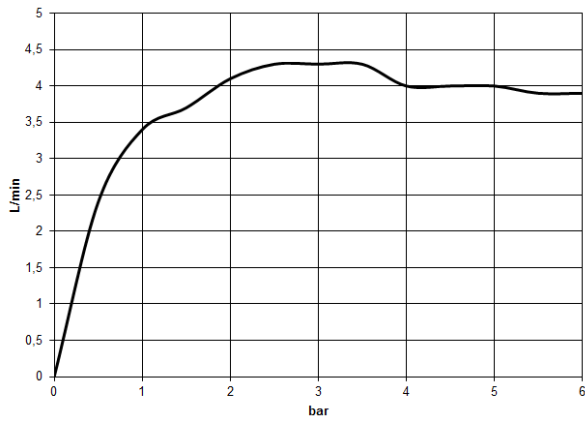

**Certificates**

GDV\_0400279.      LGA\_28686.      IAPMO\_N-4976.      IAPMO\_8834 (1).      IAPMO\_4976 (6).

WRAS\_1512011.      IAPMO\_6397.

ST 010 106 5705

Parts for other finishes can be found here: [Chrome](#)

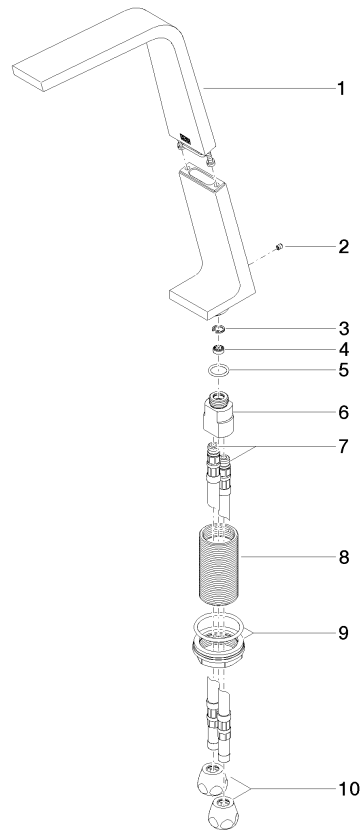







Spare parts list

| No. | Item Number        | Name               | Quantity used | Delivery time |
|-----|--------------------|--------------------|---------------|---------------|
| 1   | 90 11 70 003 00-06 | spout              | 1             | 10            |
| 2   | 09 31 11 044 90    | pin                | 1             | 2             |
| 3   | 09 16 01 016 90    | ring               | 1             | 2             |
| 4   | 09 23 01 034 90    | flow reducer       | 1             | 2             |
| 5   | 09 14 10 130 90    | seal               | 1             | 2             |
| 6   | 09 11 10 055 10 90 | connection         | 1             | 2             |
| 7   | 04 30 04 016 00 90 | hose               | 2             | 60            |
| 8   | 09 30 01 208 90    | connection         | 1             | 2             |
| 9   | 04 23 10 044 06 90 | fixing set         | 1             | 2             |
| 10  | 90 23 30 040 00-06 | threaded connector | 2             | 10            |

ST 010 106 5705

- with CASCADE structure
- hole diameter 32 mm
- rosette 60 x 47 mm
- with cold marking



|  |                               |               |
|--|-------------------------------|---------------|
|  | Brushed Platinum              | 20 006 705-06 |
|  | Chrome                        | 20 006 705-00 |
|  | Dark Chrome                   | 20 006 705-19 |
|  | Brushed Champagne (22kt Gold) | 20 006 705-46 |
|  | Champagne (22kt Gold)         | 20 006 705-47 |
|  | Brushed Dark Platinum         | 20 006 705-99 |



## CL.1 Three-hole basin mixer without pop-up waste - Brushed Platinum

---

CL.1

ST 010 106 5705

ST 010 106 5705

mm [inches]

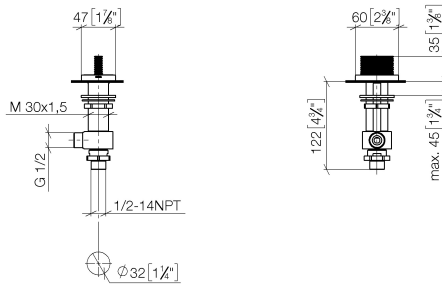

**Flow rate chart**

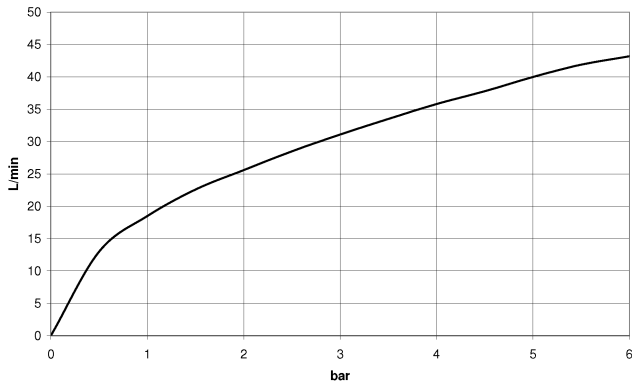

**Certificates**

WRAS\_1804020. IAPMO\_4976 (5). IAPMO\_N-4976. LGA\_28687. IAPMO\_6397.

WRAS\_240202020.



ST 010 106 5705

Parts for other finishes can be found here: [Chrome](#)

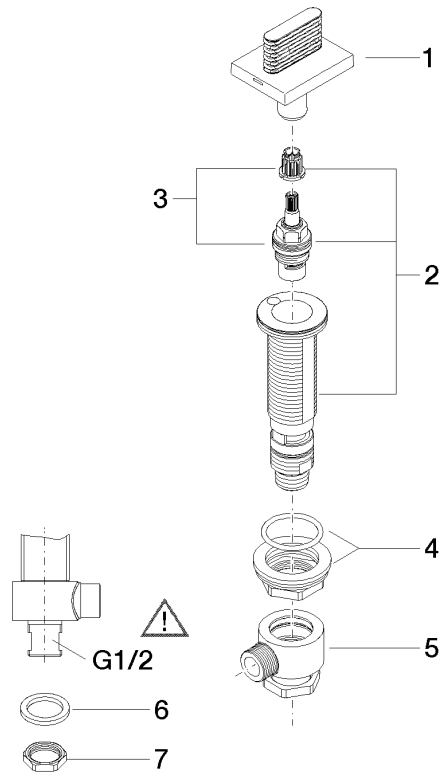







### Spare parts list

| No. | Item Number        | Name               | Quantity used | Delivery time |
|-----|--------------------|--------------------|---------------|---------------|
| 1   | 90 20 70 053 06-06 | handle ( cold )    | 1             | 10            |
| 2   | 04 17 11 058 53 90 | side panel         | 1             | 2             |
| 3   | 90 90 03 153 00 90 | top                | 1             | 2             |
| 4   | 04 23 10 032 78 90 | fixing set         | 1             | 2             |
| 5   | 04 17 11 023 10 90 | distributor        | 1             | 2             |
| 6   | 90 23 30 040 00-06 | threaded connector | 1             | 10            |
| 7   | 09 30 11 059 90    | disc               | 1             | 2             |
| 8   | 09 23 10 012 90    | nut                | 1             | 2             |

ST 010 106 5705

- with CASCADE structure
- hole diameter 32 mm
- rosette 60 x 47 mm
- with hot marking



|  |                               |               |
|--|-------------------------------|---------------|
|  | Brushed Platinum              | 20 006 706-06 |
|  | Chrome                        | 20 006 706-00 |
|  | Dark Chrome                   | 20 006 706-19 |
|  | Brushed Champagne (22kt Gold) | 20 006 706-46 |
|  | Champagne (22kt Gold)         | 20 006 706-47 |
|  | Brushed Dark Platinum         | 20 006 706-99 |



## CL.1 Three-hole basin mixer without pop-up waste - Brushed Platinum

---

CL.1

ST 010 106 5705

ST 010 106 5705

mm [inches]

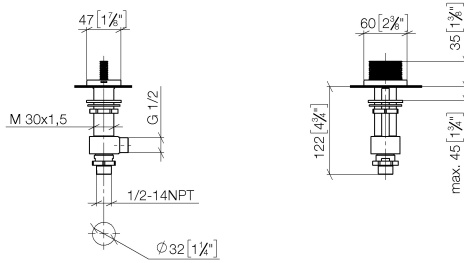

**Flow rate chart**

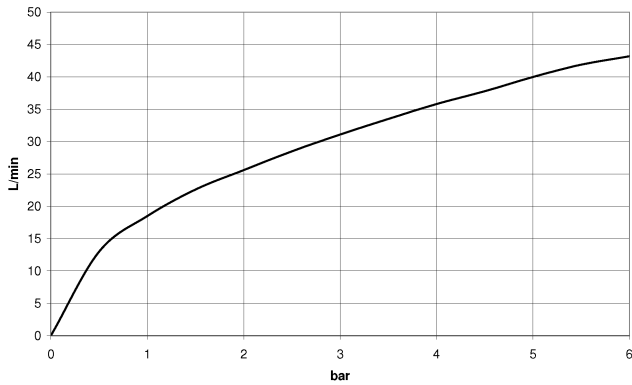

**Certificates**

WRAS\_1804020. IAPMO\_4976 (5). IAPMO\_N-4976. LGA\_28687. IAPMO\_6397.

WRAS\_240202020.

ST 010 106 5705

Parts for other finishes can be found here: [Chrome](#)

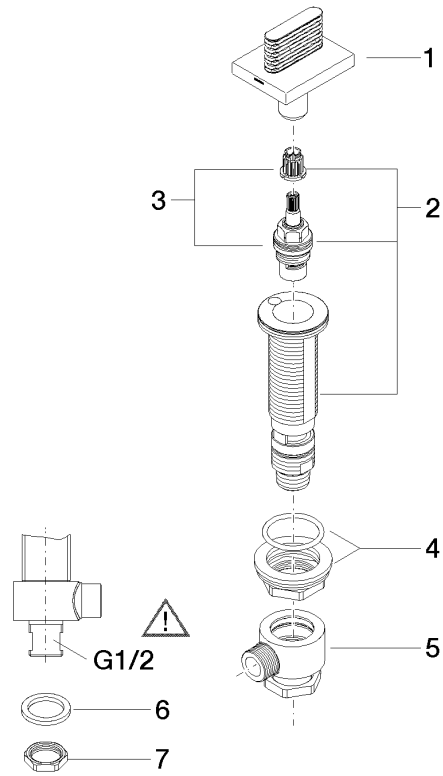

### Spare parts list

| No. | Item Number        | Name               | Quantity used | Delivery time |
|-----|--------------------|--------------------|---------------|---------------|
| 1   | 90 20 70 053 07-06 | handle ( hot )     | 1             | 10            |
| 2   | 04 17 11 058 52 90 | side panel         | 1             | 2             |
| 3   | 90 90 03 152 00 90 | top                | 1             | 2             |
| 4   | 04 23 10 032 78 90 | fixing set         | 1             | 2             |
| 5   | 04 17 11 023 10 90 | distributor        | 1             | 2             |
| 6   | 90 23 30 040 00-06 | threaded connector | 1             | 10            |
| 7   | 09 30 11 059 90    | disc               | 1             | 2             |
| 8   | 09 23 10 012 90    | nut                | 1             | 2             |